

Lista de precios

03.2023

Lavavasos y lavaplatos industriales





Indice

Lav 135	3
Lav 140	4
Lav 150	5
Lav 1000	6
Cestas y accesorios	7



Modelo	Cod.	€
Lav 135	919015	1.329,00

Optional	Cod.	€
Bomba de desagüe	999354	205,00
Dosificador de detergente	999347	260,00

Equipamiento	Cod.
 n. 2	780138
 n. 1	780139

Datos técnicos		
Dimensiones	cm	40.1x49x59.5
Altura puerta	cm	26
Altura máxima plato	cm	-
Altura máxima vaso	cm	25
Ciclo de lavado	sec.	120
Cesta	cm	35x35
Consumo de agua	L/ciclo	2
Bomba propulsora	kW	0.15
	L	7
Cuba	kW	0.6
	°C	60
	L	2.6
Calderín	kW	2.6
	°C	65
Potencia instalada	V/Hz/Ph	230/50/1
	kW	3.5
Dosificador peristáltico de abrillantador		✓

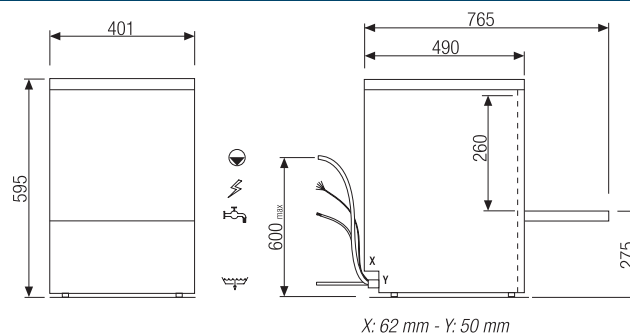

Diagrama de instalación





Modelo	Cod.	€
Lav 140	919016	1.590,00
Lav 140 BD	919017	1.851,00

* version con bomba de desagüe

Equipamiento	Cod.
 n. 2	780133
 n. 1	780139

Optional	Cod.	€
Bomba de desagüe	999354	205,00
Dosificador de detergente	999347	260,00

Datos técnicos

Dimensiones	cm	43.6x53.5x67
Altura puerta	cm	32
Altura máxima plato	cm	30
Altura máxima vaso	cm	30
Ciclo de lavado	sec.	120
Cesta	cm	39x39
Consumo de agua	L/ciclo	2
Bomba propulsora	kW	0.2
	L	8
Cuba	kW	0.6
	°C	60
	L	2.6
Calderín	kW	2.6
	°C	65
Potencia instalada	V/Hz/Ph	230/50/1
	kW	3.5
Dosificador peristáltico de abrillantador		✓

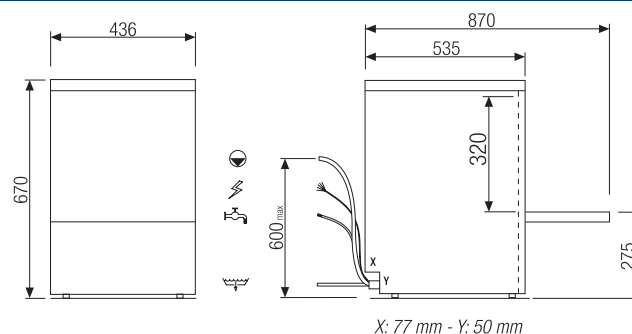

Diagrama de instalación





Modelo	Cod.	€
Lav 150	919018	2.132,00
Lav 150*	919019	2.373,00

* version con bomba de desagüe

Equipamiento	Cod.
 n. 1	780131
 n. 1	780132
 n. 1	780139

Optional	Cod.	€
Bomba de desagüe	999342	240,00
Dosificador de detergente	999347	260,00

Datos técnicos

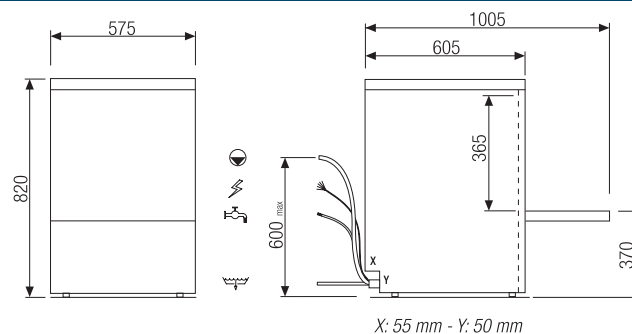

Dimensiones	cm	57.5x60.5x82
Altura puerta	cm	36.5
Altura máxima plato	cm	36.5
Altura máxima vaso	cm	32.5
Ciclo de lavado	sec.	90 - 150
Cesta	cm	50x50
Consumo de agua	L/ciclo	2.4
Bomba propulsora	kW	0.47
	L	20
Cuba	kW	2.1
	°C	60
	L	6
Calderín	kW	3
	°C	80
Potencia instalada	V/Hz/Ph	230/50/1
	kW	3.5
Dosificador peristáltico de abrillantador		✓

Diagrama de instalación





Modelo	Cod.	€
Lav 1000	TH50STN4	4.034,00

Equipamiento	Cod.
	n. 1 780131
	n. 1 780132
	n. 1 780139





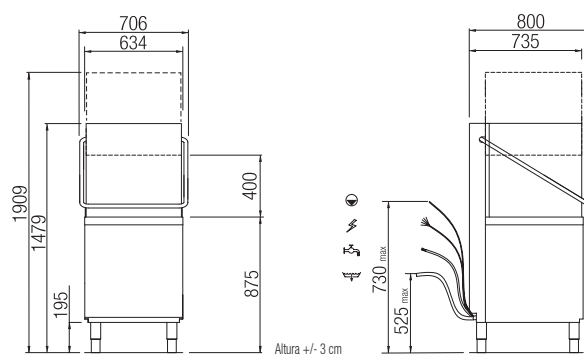

Optional	Cod.	€
Bomba de desagüe	70710	250,00
Dosificador de detergente	41954	250,00

Datos técnicos	
Dimensiones	cm 63.4x73.5x147.9
Altura puerta	cm 40
Altura máxima plato	cm 40
Altura máxima vaso	cm 39
Ciclo de lavado	sec. 90 - 150
Cesta	cm 50x50
Consumo de agua	L/ciclo 2.4
Bomba propulsora	kW 0.47
	L 15
Cuba	kW 2.1
	°C 60
	L 6
Calderín	kW 8
	°C 80
Potencia instalada	V/Hz/Ph 400/50/3N
	kW 8.5
Dosificador peristáltico de abrillantador	✓

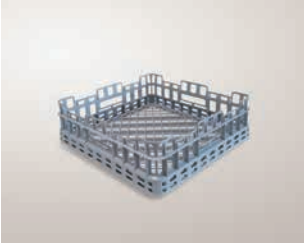
Diagrama de instalación

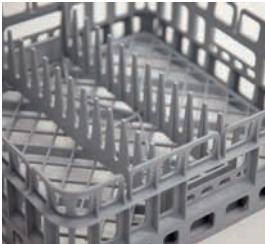

Cestas y accesorios

Mod.	Dim. (cm)	Cod.	€
	35x35	780138	72,00
	39x39	780133	75,00
	50x50	780132	75,00
	50x50	780131	75,00
	31x9	712020	25,00
		780140	33,00
	11x11x14	780139	16,00
	60x60x38	798006	476,00

